

**ROO**

hidroglass  
 mamparas bifolding 2

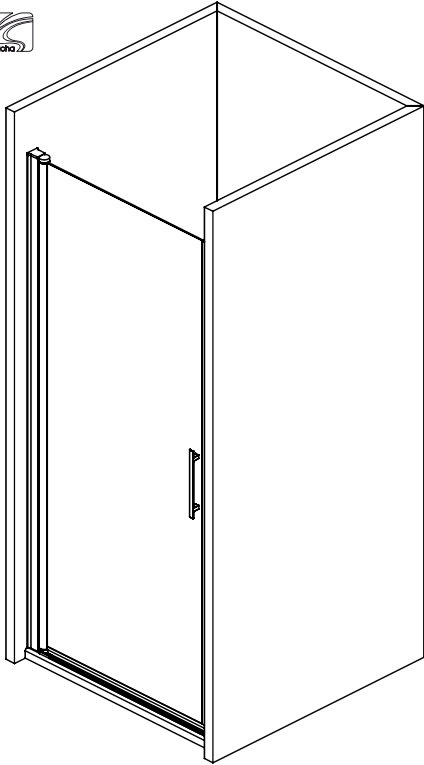

**ACCESORIOS**

<b>X1</b>  VIDRIO HOJA	<b>X1</b>  PERFIL SOPORTE PARED ABATIBLE	<b>X1</b>  PERFIL EXPANSOR ABATIBLE	<b>X1</b>  PERFIL HOJA ABATIBLE	<b>X1</b>  TIRADOR 225MM
	<b>X1</b>  PERFIL BASE	<b>*X1</b>  PIEZA IZQ. EMB. VARILLA PARA BISAGRA ABATIBLE	<b>*X1</b>  PIEZA DCH. EMB. VARILLA PARA LADO DERECHO	
<b>X1</b>  TAPA PERFIL SOPORTE PARED	<b>X1</b>  PIEZA SOPORTE SUPERIOR EXPANSOR	<b>X1</b>  PIEZA SOPORTE INFERIOR EXPANSOR	<b>X1</b>  TAPON SUPERIOR PERFIL HOJA	<b>X1</b>  TAPON INFERIOR PERFIL HOJA
<b>X1</b>  PGE-1012	<b>X1</b>  PGE-1154/6	<b>X2</b>  TAPETA	<b>X3</b>  TACO 6	<b>X3</b>  4.8x32
<b>X2</b>  4.8x16	<b>X3</b>  ARANDELA 6mm			

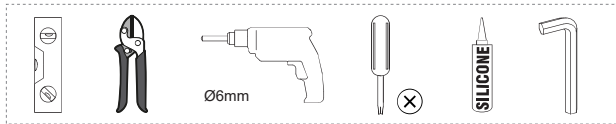

\*La cogida de esta pieza dependerá de la mano de la mampara

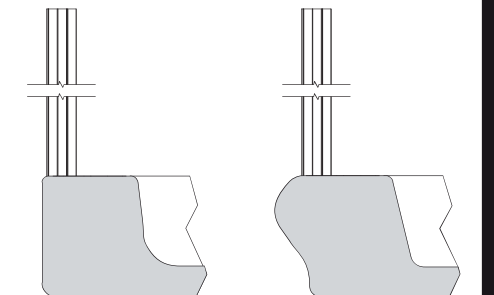
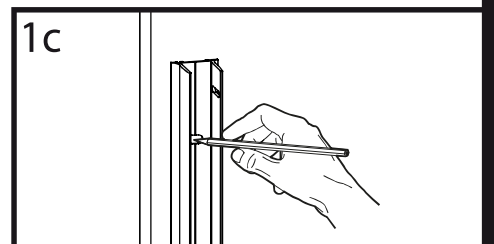
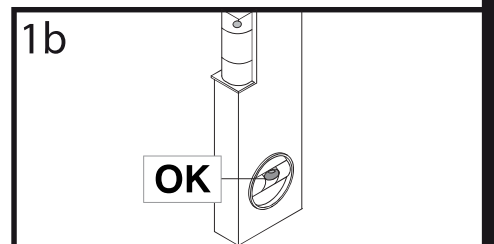
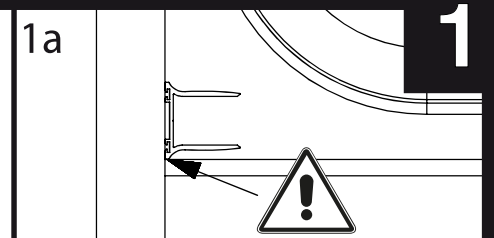
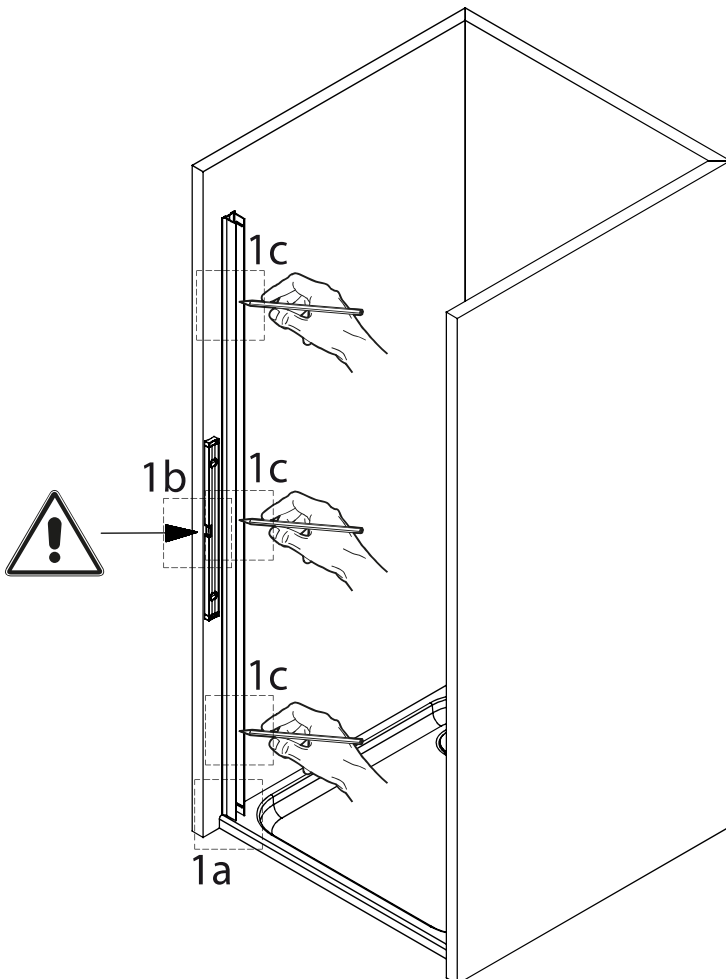

BROCA 6 mm

4.8x32

TACO 6 mm

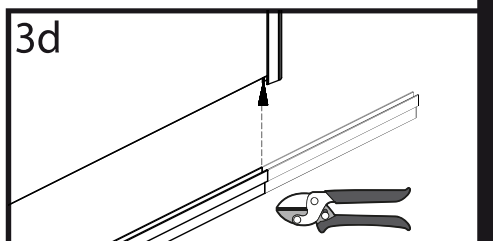
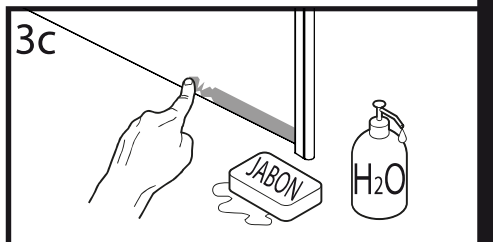
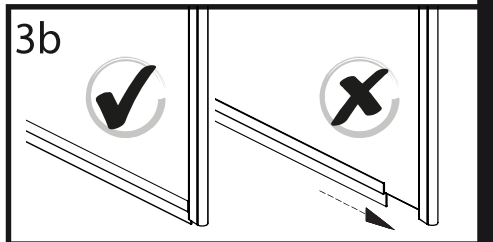
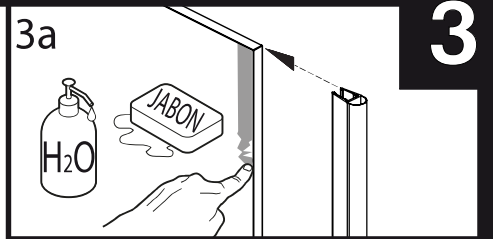
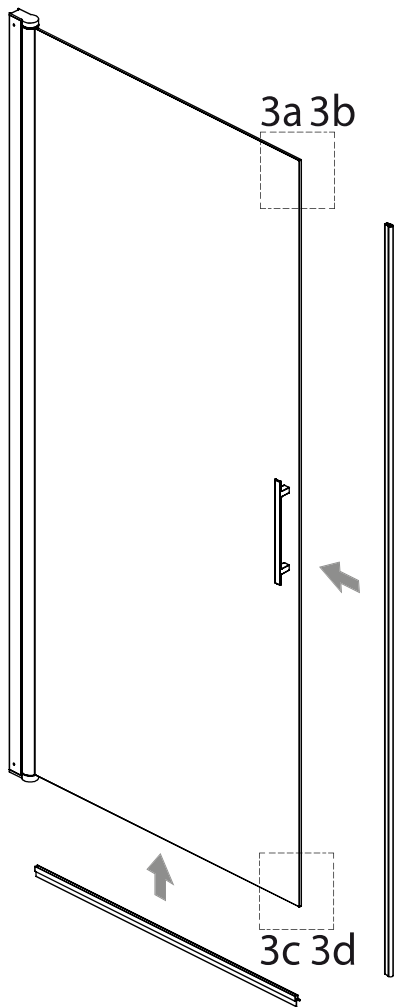
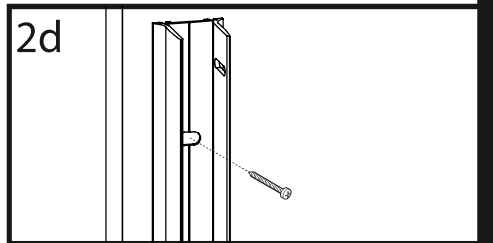
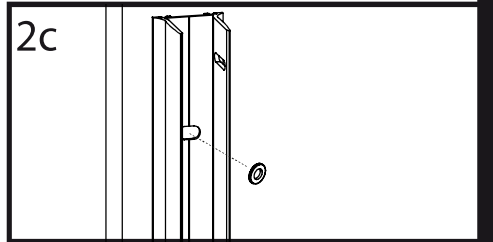
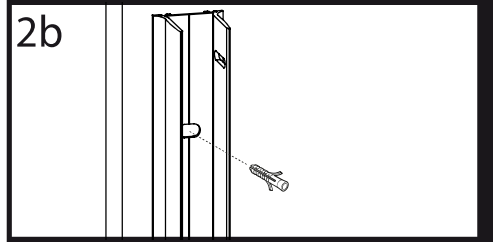
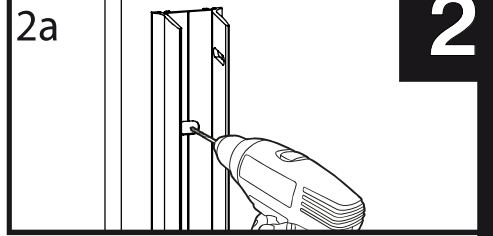
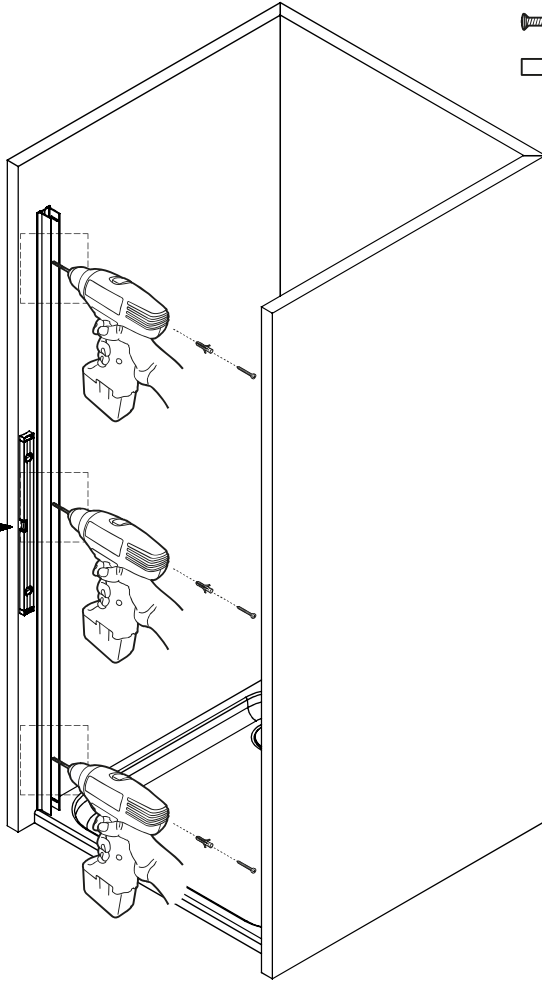

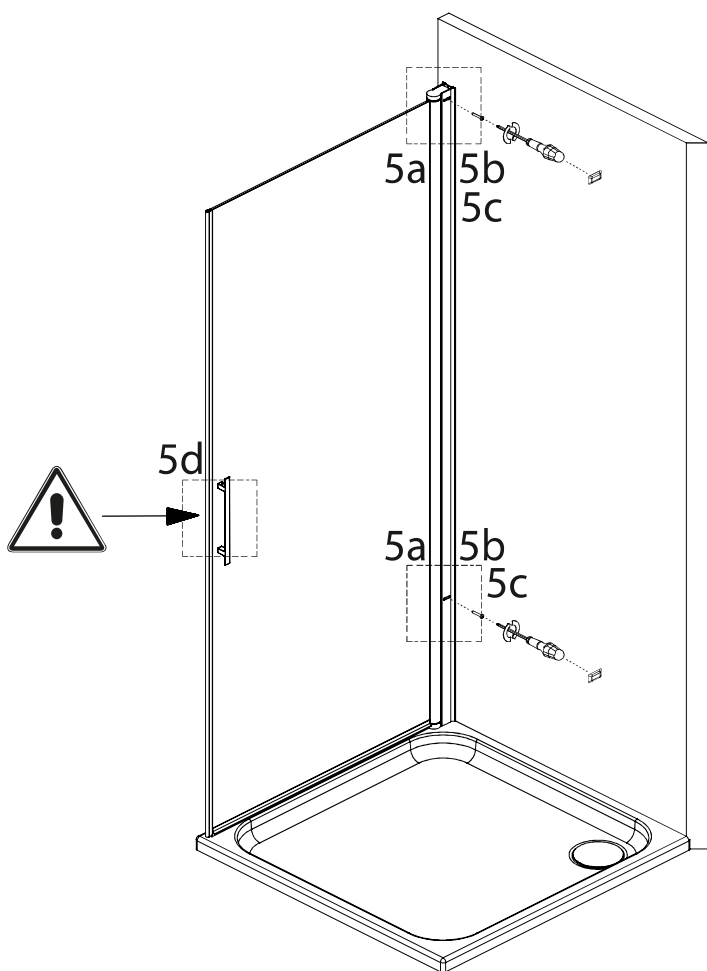
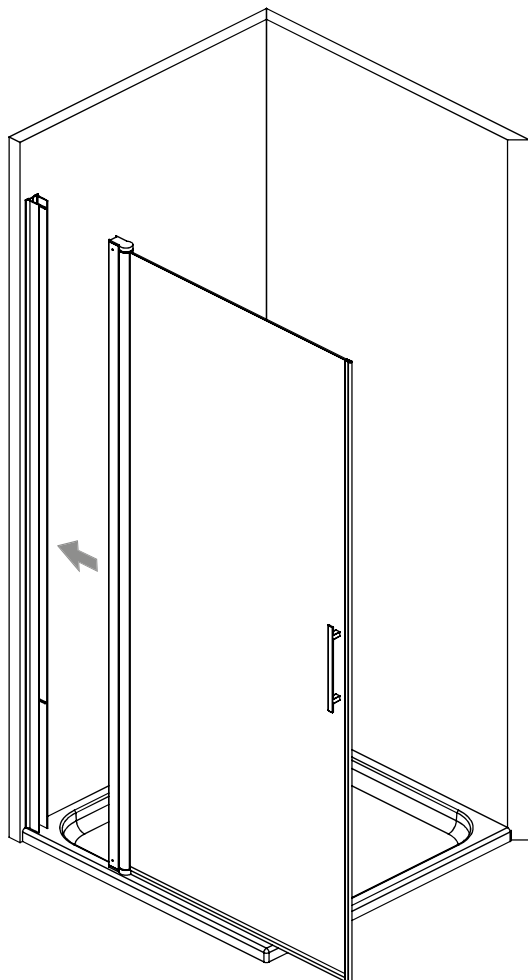

4.8x16mm

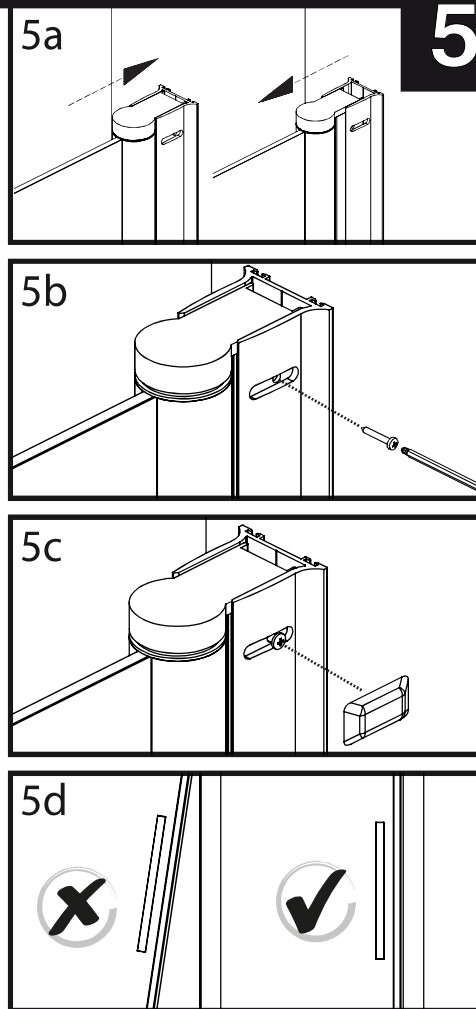

6

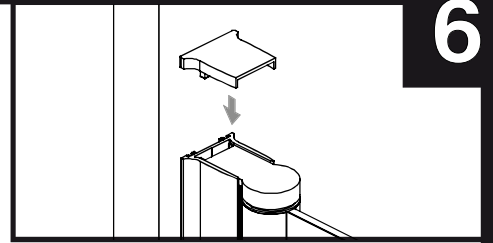
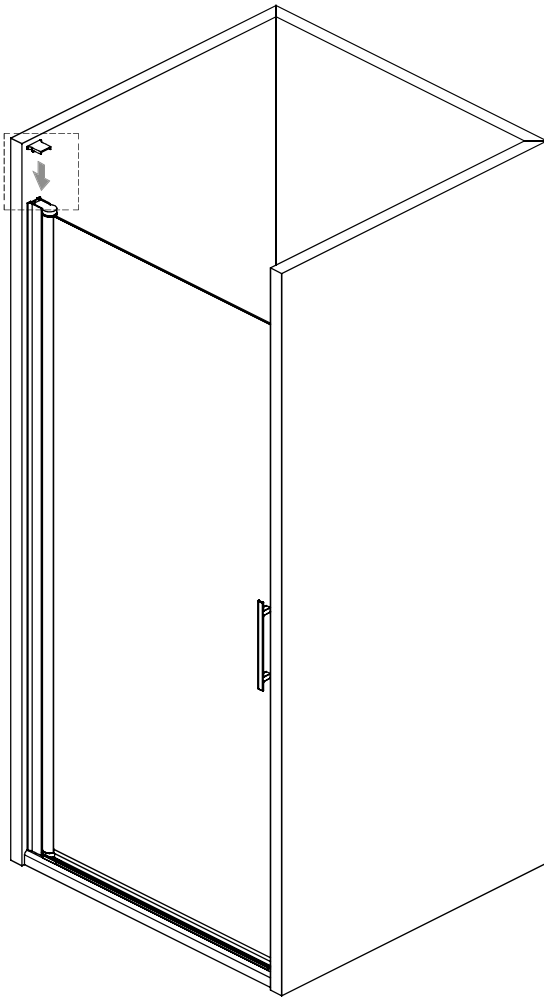

7

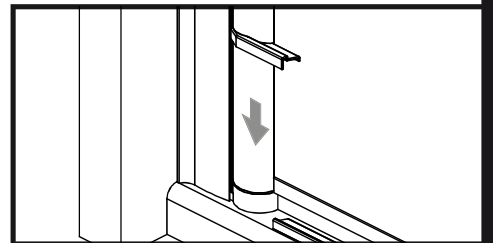
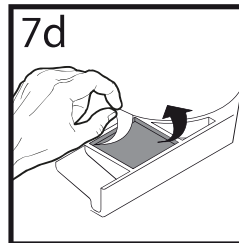
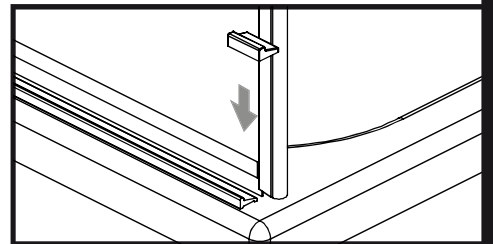
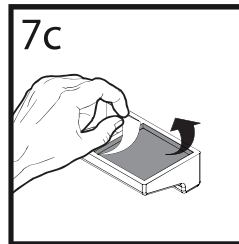
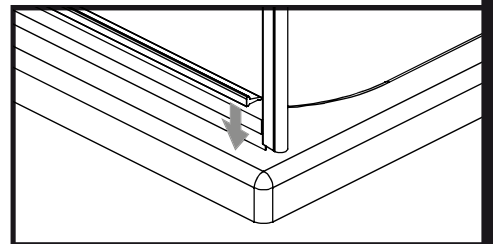
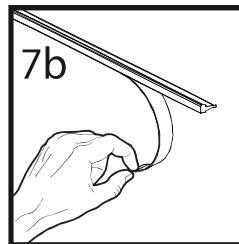
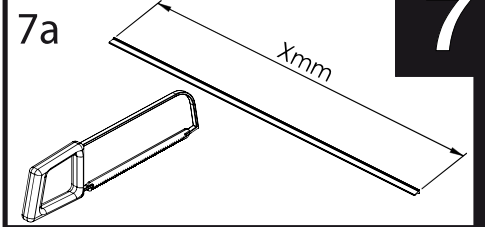
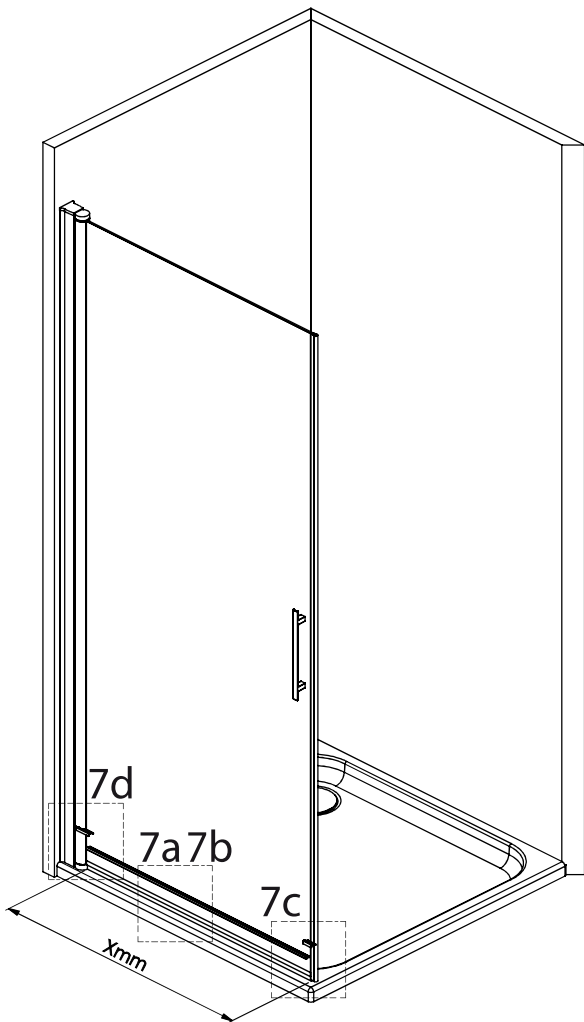

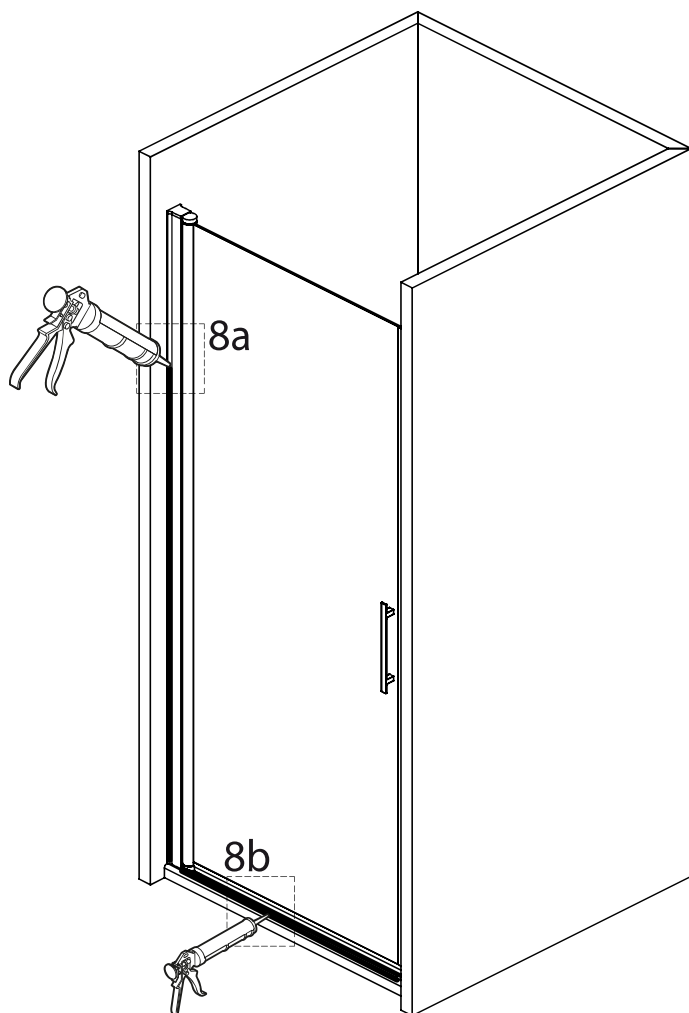

8a

8b

## ! LIMPIEZA

Para el cuidado de los productos Hidroglass y mantenerlos en perfecto estado, se aconseja secar con un paño o bayeta los accesorios (Bisagras y componentes), que estén en contacto con el agua, así evitaremos que se deposite la cal en los accesorios, después diluir en un paño un poco de jabón líquido con agua para limpiarlo perfectamente.

### ATENCIÓN

No emplear nunca, detergente con sustancias abrasivas o con base ácida, amoníaco, acetona, lejía, ácidos varios, vinagre puro o esponjas abrasivas. El uso de los productos, pueden deteriorar irremediamente la superficie de los accesorios e Hidroglass no se hará responsable.

### CONSEJOS PARA EL MANTENIMIENTO Y LIMPIEZA

La cal y la suciedad depositada en los accesorios se podrán lavar con una solución de agua y vinagre (concentración máxima de vinagre 15%, que sería 15 ml de vinagre en un litro de agua) después lavar con agua y jabón y aclarar.

Care products Hidroglass and keep in perfect condition, it is advisable to dry with a cloth or cloth accessories (hinges and components), which are in contact with water, thus avoiding the deposit of lime in the accessories, then dilute cloth in a little liquid soap with water to clean perfectly.

### ATTENTION

Never use, detergent based abrasives or acid, ammonia, acetone, bleach, various acids, pure vinegar or scouring pads. The use of the products, can damage the surface beyond Hidroglass accessories and will not be responsible.

### TIPS FOR MAINTENANCE AND CLEANING

The lime and dirt deposited on accessories may be washed with a solution of water and vinegar (maximum concentration of 15% vinegar, that would be 15 ml of vinegar in a quart of water) after washing with soap and water and rinse.

Para produtos de cuidados Hidroglass e mantê-los em bom estado, recomendo secar com um pano ou um pano acessórios (dobradiças e componentes), que estão em contato com a água, por isso evite cal é depositado nos acessórios, em seguida, diluir em um pano um pouco de sabão líquido com água para limpá-lo perfeitamente.

### ATENÇÃO

Nunca use, detergentes abrasivos ou a base de ácido, amônia, acetona, água sanitária, vários ácidos, vinagre puro ou esponjas abrasivas. O uso dos produtos, pode danificar a superfície além do reparo e acessórios Hidroglass não deve ser responsabilizada.

### DICAS PARA MANUTENÇÃO E LIMPEZA

Cal e sujidade depositada sobre os acessórios podem ser lavadas com uma solução de água e vinagre (concentração máxima de 15% de vinagre, que seria de 15 ml de vinagre em um litro de água), em seguida lavar com água e sabão e enxaguar.